

Instruction Manual

Automated Nucleic Acid Purification System

ZiXpress 64 Dx system



Catalog No.: 112C2

Rev. Date: 20.06.2024

Manual No. IFU-ZP01-112C2

Version: 1.6



ZINEXTS LIFE SCIENCE CORP.

16F., No. 93, Sec. 1, Xintai 5th Rd.,
Xizhi Dist., New Taipei City 221416,
Taiwan (R.O.C.)



Obelis s.a.
Bd Général Wahis 53
1030 Brussels Belgium
Tel: +(32) 2 732-59-54
Fax: +(32)2 732-60-03
mail@obelis.net



TABLE OF CONTENTS

	<u>Page #</u>
1. Introduction	2
1.1 About ZiXpress 64 Dx system	2
1.2 Technology Introduction.....	2
1.3 Safety Information	3
1.4 Important Instructions.....	4
2. Intended Use & Specifications	6
2.1 Intended Use.....	6
2.2 Specifications.....	6
2.3 Environment Requirements	6
2.4 Dimension and Weight.....	7
3. Instrument Overview	8
4. Installation	10
4.1 Composition of the ZiXpress 64 Dx system	10
4.2 Operating Environment / Conditions.....	12
4.3 Initial Setting	14
4.4 Notes for Transportation / Shipping	16
4.5 Functional Descriptions.....	17
5. Getting Started	20
5.1 Preparation.....	20
5.2 Operation.....	21
6. Cleaning & Maintenance	29
7. Troubleshooting	30
8. Contact Zinexts Life Science	31
9. Warranty Information	32

INTRODUCTION

About ZiXpress 64 Dx system

Thank you for purchasing ZiXpress 64 Dx system for your laboratory. This guide contains important information regarding the safe use of the ZiXpress 64 Dx system. Please read this manual carefully, before starting to operate the instrument for the first time, especially the Safety Information.

If there is any question about how to install or operate it, please contact our certified representatives / agents or email our technical support center (support@zinexts.com).

Technology Introduction

Principle

ZiXpress 64 Dx system utilizes the unique characteristic of magnetic beads bonding with nucleic acid under a specific environment to purify the target nucleic acid samples. The purification protocol includes four basic steps: sample lysis, nucleic acid binding, wash and elution. Using ZiXpress 64 Dx system, the majority of nucleic acid purification processes will be done automatically inside of ZiXpress 64 Dx system, it dramatically reduce the human error and use the lab force much more efficiently.

During the purification process, a 8-link rod comb, which is attached to the tip comb rack, moves up and down repeatedly to mix the reagents by creating turbulences in the 96 Deep-Well Plate. When the permanent magnetic rods are insert into the rod combs, the assembly lowers into the solution to collect the magnetic beads at the bottom of the comb. The whole assembly then move to a different Well and the magnetic beads are then release by retracting the permanent magnetic rods. ZiXpress 64 Dx system equips an exclusive temperature control module that perfectly connect with the 96 Deep-Well Plate to enhance the lysis and elution efficiency.

Applications

ZiXpress 64 Dx system purifies DNA and RNA from a variety of samples which are essential and broadly used in molecular biology, genetic screening, sequencing, food safety, forensic, etc.

Safety Information



Attention

This chapter presents safety information that you need to be familiar with and strictly follow before you operate, maintain or service this instrument. If you failed to follow the safety information, or neglected the warning in this user manual, it might cause damage to the instrument. Please note that operating the instrument outside its intended use might lead to personnel injury and material loss.

For your safety and those of others, follow the guidelines provided in the following pages concerning the use of the ZiXpress 64 Dx system.

ZINEXTS LIFE SCIENCE CORP. will not be held liable for any errors, damage, or other unexpected events resulting from miscarried following safety guideline.

Safety Symbols & Labels

Safety		The meanings of safety precaution marks are as follows:
Warning		“ WARNING ” indicates a dangerous condition that may lead to death or serious injury.
Biohazard		This symbol is used to indicate that certain precautions must be taken when working with potentially infectious material.
Caution		This symbol is used to indicate that non-compliance with instructions or procedures may lead to physical injury or even death or could cause damage to the instrument.
Important		“ IMPORTANT ” shows the important notes for usage, as well as prohibited actions.
Note		“ NOTE ” indicates the notes, procedures that should be obeyed and supplementary information for use.
Hot surface		This symbol is used to label potentially hot instrument surfaces.

Important Instructions

Read First!

For your safety and those of others, follow carefully the guidelines provided in the following pages concerning the use of the **ZiXpress 64 Dx system**.

About Instrument

Warning:

- Make sure the instrument is installed in a well ventilated environment and away from any water source
- Make sure the power source is matching the rating, labelled on the instrument
- Turn off, remove the power cord and cover the instrument before a period of non-use or any transportation
- The power cord is one of the emergency power supply control, please do not place the power cord in a location hard to reach
- If you heard or smelled anything during the operation, please immediately disconnect the power and contact your local representative / agent



Caution:

- Never attempt to remodel the **ZiXpress 64 Dx system** without the manufacturer's permission
- Do not place or drop objects on the **ZiXpress 64 Dx system**. Also, refrain from bumping or knocking it.
- Repairs to the **ZiXpress 64 Dx system** should be only performed by representatives / agents that are specifically authorized, and with original spare parts that are certified by the **ZINEXTS LIFE SCIENCE CORP.**
- If the equipment is used in a manner not specified by the manufacturer, the protection provided by the equipment may be impaired.

About Reagent Kits



Caution:

- When handling any of the kits, refer to the respective handbook.
- Reagents in each kit should be handled by observing the

safety information and precautions regarding the kit.

- Extraction should be performed in an appropriate laboratory or workspace.
- **Note:**
- Reagent kits will be generally not supplied with the **ZiXpress 64 Dx system** instrument. Please select your desired Reagent Kits and order them separately.

About Samples



Biohazard:

Always wear appropriate gloves, a mask, and safety goggles etc. when handling any infectious samples.

About Infectious Wastes

When handling or disposing of infectious materials, follow the laboratory guideline or the law regarding infectious waste to perform proper incineration, fusion, sterilization, and/or disinfection.

When you use a third party to dispose of it, outsource this work an operator licensed to handle medical waste subject to special control, and give them the manifest of the medical waste at the same time.

INTENDED USE & SPECIFICATIONS

Intended Use This product and any of its accessories is for the extended use of nucleic acid extraction, purification isolation in molecular biology research laboratories and clinical diagnosis laboratories.

Specifications

<u>Product Specifications</u>	Model Name	ZiXpress 64 Dx system
	Instrument Type	Bench-top automated Nucleic Acid Extractor
	Sample Processing	1 - 64 samples per batch
	Consumable	2.2 ml 96 Deep-Well Plate
	Collection Efficiency	100 copies/mL, positive detecting rates > 95%
	Inter-Well Purification Accuracy	CV < 3%
	Heat Block Temperature	Room temperature to 80 °C
	Mixing Speed	3 adjustable speeds
	Reagent Type	Magnetic Beads
	Control Interface	7-inch touch panel
	Protocol	4 preset protocols; 16 user-defined protocols
	Decontamination	Built-in UV light
	Fuse	F3.15A 250V

Environment Requirements

<u>Operating</u>	Environment temperature:	10 - 40°C
	Relative humidity:	< 80%
	Power rating:	AC 100-240V, 400VA, UPS optional
<u>Storage</u>	Environment temperature:	-20 - 55°C
	Relative humidity:	≤ 80%

Transportation

Environment temperature: -20 - 55°C
Relative humidity: < 80%

Dimension & Weight

Dimensions: 722 x 360 x 490 mm

Weight: 38 kg

EMC EN61326-1

Safety EN60101-1, EN60101-2

INSTRUMENT OVERVIEW

Front view

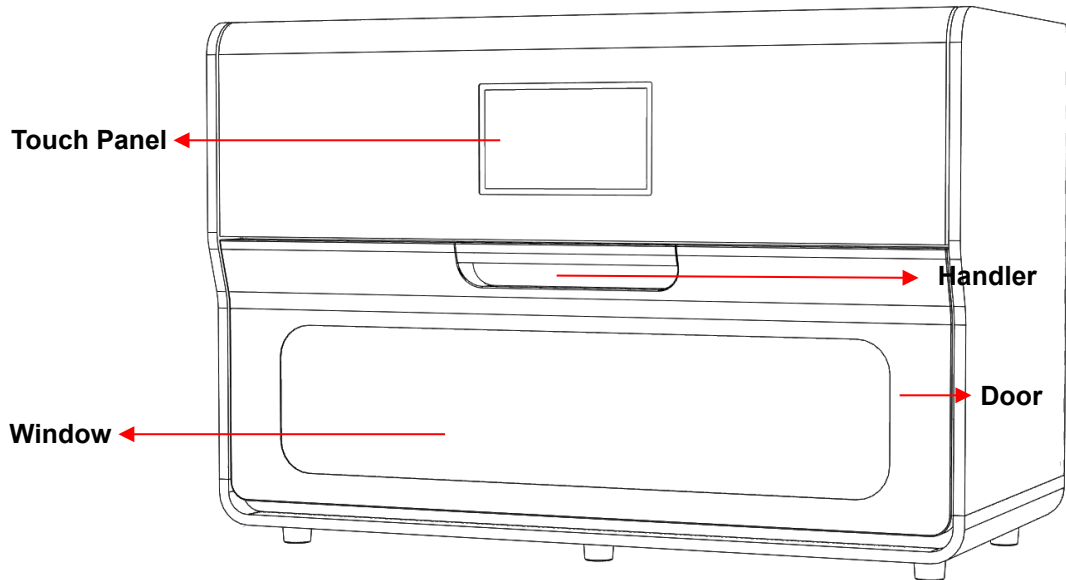

Rear view

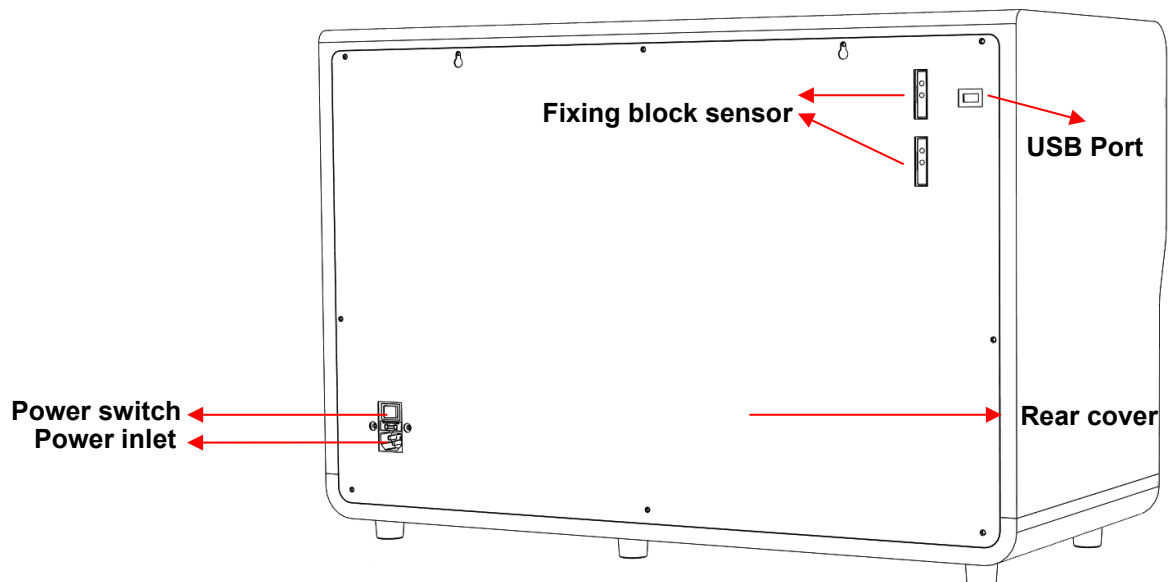

Inside view

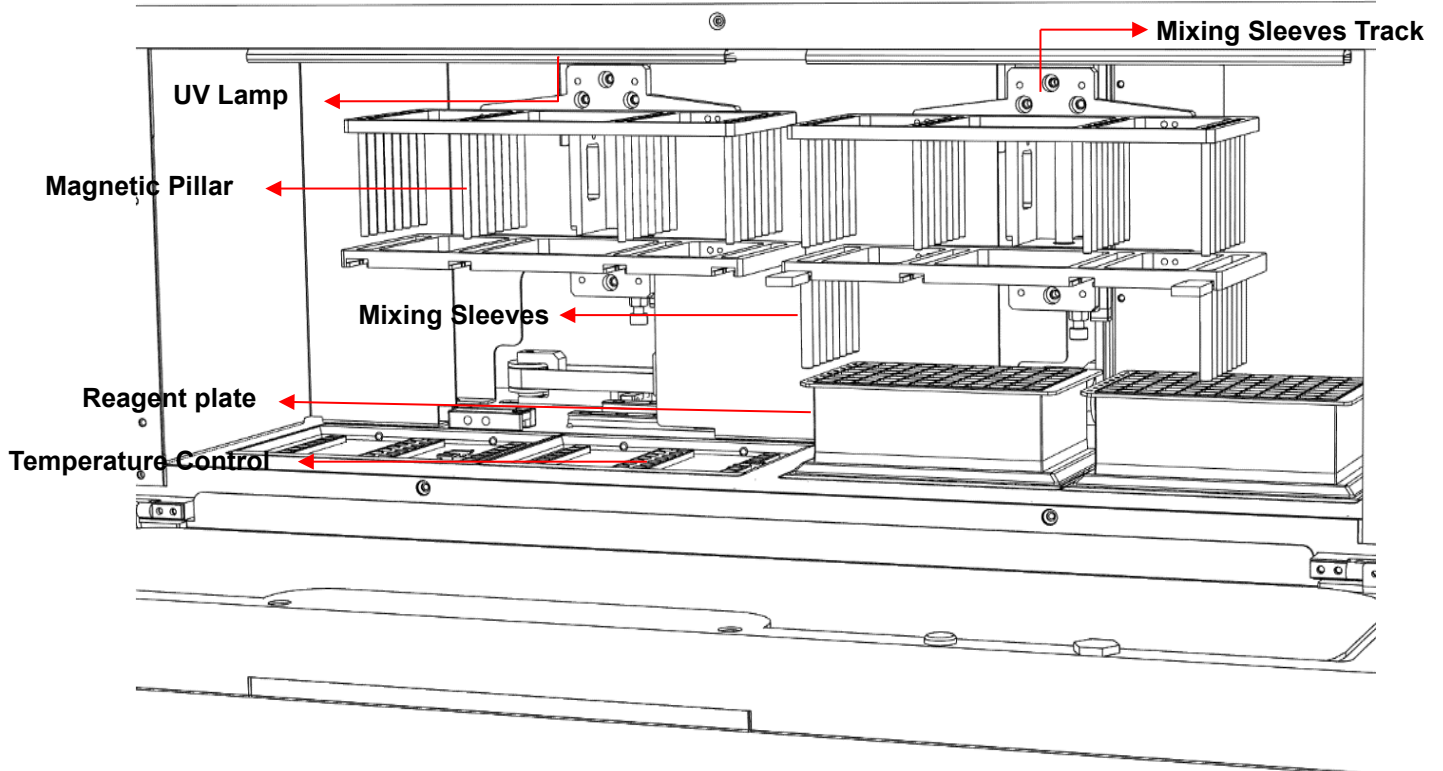
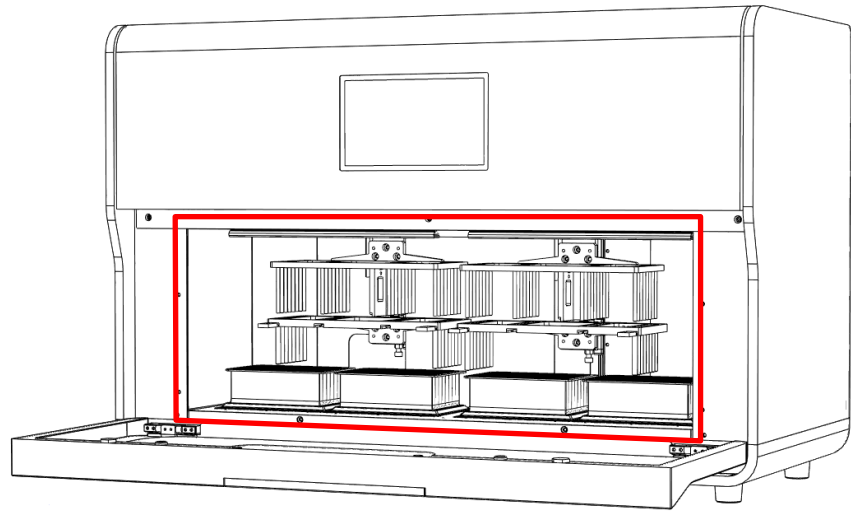

INSTALLATION

Composition of the ZiXpress 64 Dx system

Packaging

Check that the following parts are included in the package. Contact your local representative if you notice any missing part(s).

Instrument

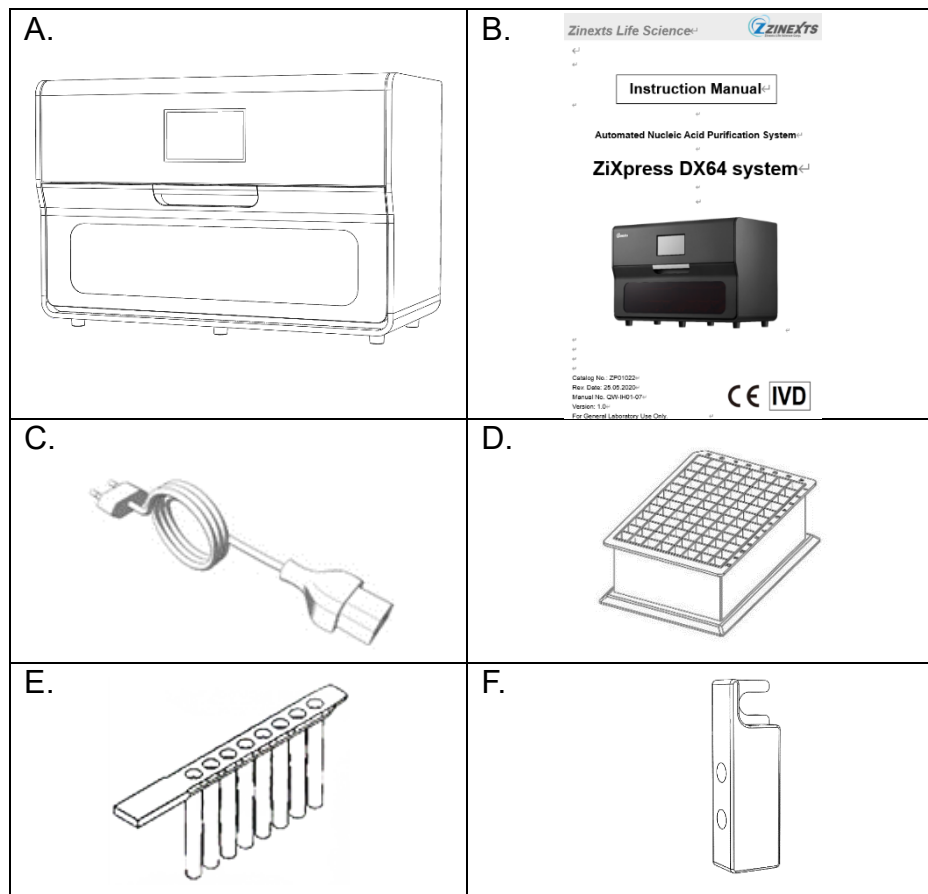

Quantity:

- | | | | |
|---------------|----|----------------------------|----|
| A. Instrument | x1 | B. User Manual | x1 |
| C. Power Cord | x1 | D. 2.2ml Deepwell 96 Plate | x4 |
| E. 8-Tip Comb | x4 | F. Fixing block | x1 |

Please make sure all components are free of damages as soon as you get the system. If any damage is found, please contact your local representative for support.

Note:

Zinexts Life Science's global warranty does not cover

transportation damages or improper handling and operation.

Extraction Kits

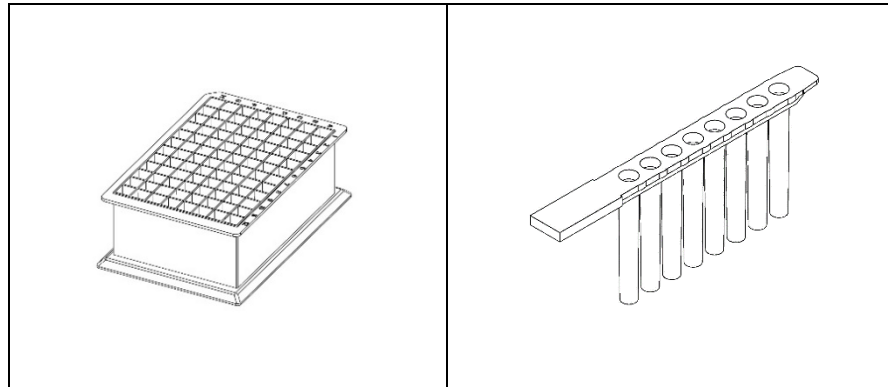

Quantity:

- | | |
|----------------------------|--------------|
| A. 2.2ml Deepwell 96 Plate | x12 (plates) |
| B. 8-Tip Comb | x24 (pcs) |

Note:

Extraction kits have to be purchased separately. Please contact your local representative / agent for further information.

The contents of extraction kits are various. Refer to the Reagent Kit Handbook, enclosed in the reagent box, for further details.

Operating Environment / Conditions

ZiXpress 64 Dx system
Operating Environment

Use the **ZiXpress 64 Dx system** in an environment that meets the following conditions:

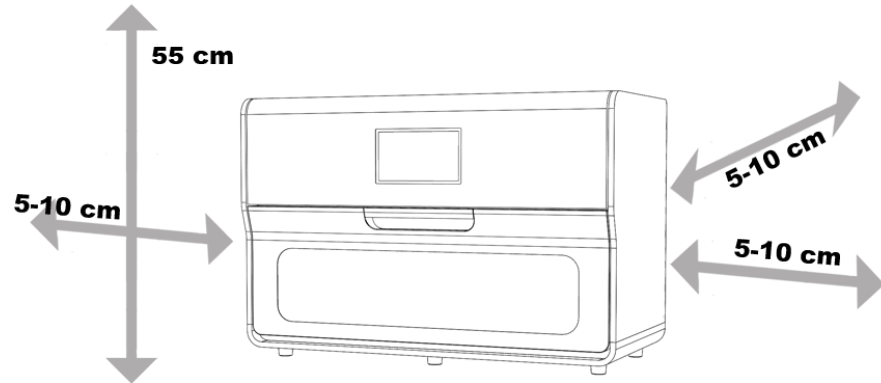

- The space for the allocation of **ZiXpress 64 Dx system** must secure 5-10 cm distance from the instrument to the wall.
- A location where power can be provided.
- A location with a temperature between 10 - 40°C, and a humidity of < 80%RH (non-condensing)
- A location with a stable temperature (Warming a cold room suddenly or moving the instrument from a room with low temperature to a warm room may cause condensation inside the device, that might resulting in abnormal extraction!)
- A location that is flat and stable, without external vibrations
- A location away from direct sunlight (If necessary, block the sunlight by closing curtains or blinds)
- A location which is well ventilated and not dusty
- A location far from objects which generate strong magnetic fields, as motors, transformers, TV, audio speakers, magnets, etc. (Bringing the **ZiXpress 64 Dx system** close to any type of magnetic field may cause a malfunction.)

Warning:

Do not use the **ZiXpress 64 Dx system** in an environment where it is wet or can be splashed with water. It may cause a device failure, fire, or electric shock.

When relocating the **ZiXpress64 DX system**, disconnect the plug from the outlet first. If the power cable is damaged, this may cause a device failure, fire, injury, or electric shock.



Caution:

Do not use the **ZiXpress 64 Dx system** in an unstable place such as a slanted surface or a place subject to vibrations. It may cause injury or device failure.

Do not use the **ZiXpress 64 Dx system** in direct sunlight or close to a heating device. It may shorten the life of the **ZiXpress 64 Dx system**, or cause trouble.

ZiXpress 64 Dx system Operating Conditions

Items		Conditions
Temperature (°C)	During operation	10 - 40
Humidity (RH)	During operation	< 80%
Max. wet bulb temperature (°C)	During operation	29 (non-condensing)
	During down time	29 (non-condensing)
Temperature gradient (°C/hr)		12 or less (non-condensing)
Humidity gradient (RH/day)		30 or less (non-condensing)
Altitude, operating (m)		1600 or less

Initial Setting

ZiXpress 64 Dx system Settings

- (1) Open the packing box and take out the instrument and related accessories.

Important:

The **ZiXpress 64 Dx system** has a weight of more than 25kgs.

It should be lift and moved by two persons. Hold the moving handler of the instrument from two sides to move it out of the transportation box.

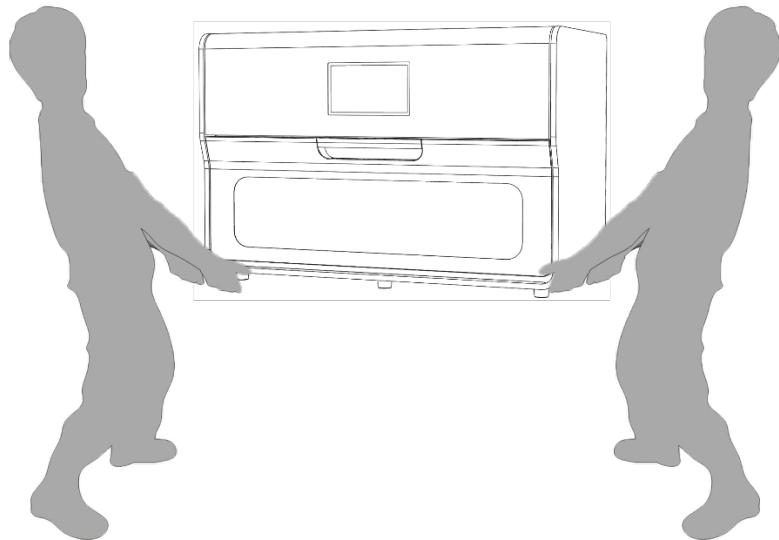

Do not hold the door or the plastic outer covering while transporting the instrument.



Caution:

Improper handling of the movement of the **ZiXpress 64 Dx system** will lead to instrument damages.

For correct and safe use of the **ZiXpress 64 Dx system**, install it in a location that is close to electrical outlet and has enough space for installation and operation from the main switch.

Important:

Keep the shipping box and fixing block, they are needed for transporting the **ZiXpress 64 Dx system**.

(2) Connect power cord to the instrument.

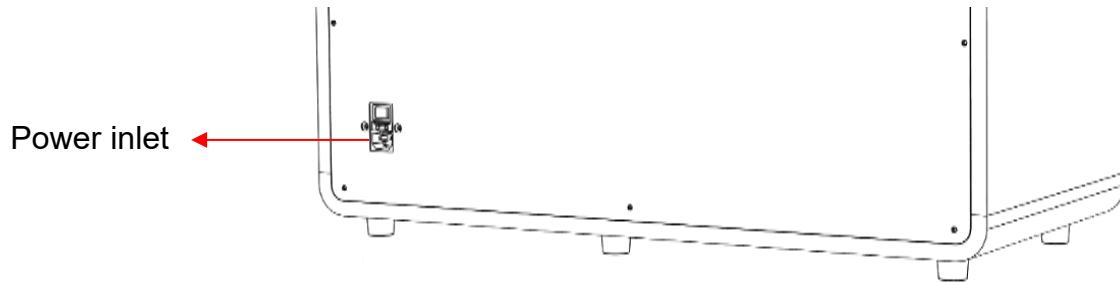

(3) Remove the Fixing Block inside the instrument and place it in the Fixing Block Sensor Spot, following the guideline below:

1. Plug in the power cord to the electric outlet
2. Use a Phillips head screwdriver to release the red screws
3. Remove the Fixing Block
4. Place the Fixing Block in the upper part of the back of the instrument, in the Fixing Block Sensor Spot. Without performing this step, the sensor will not allow the instrument to operate.

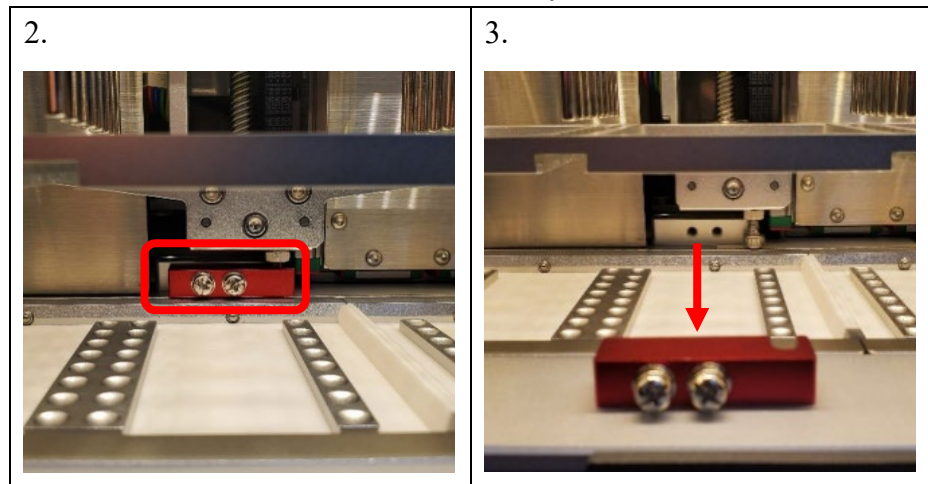

4.

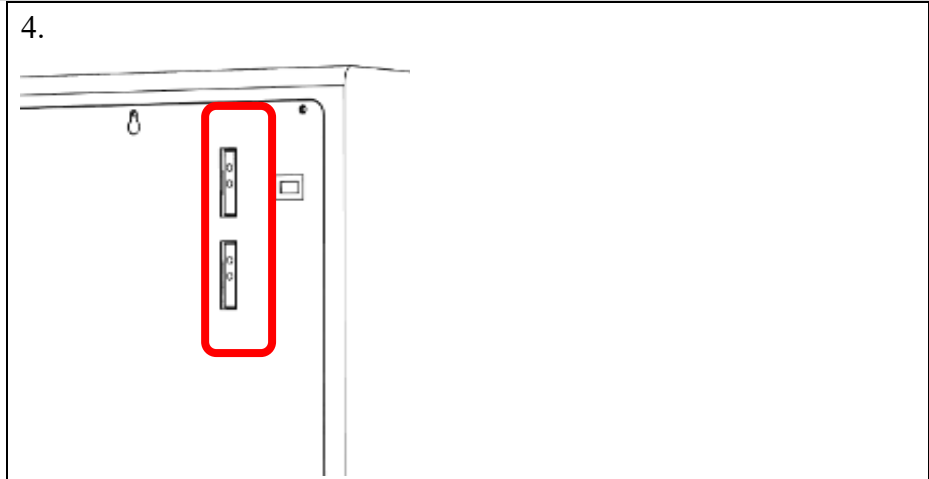

Notes for Transportation / Shipping

ZiXpress 64 Dx system Transportation

When transporting / shipping the **ZiXpress 64 Dx system** to a new location, perform the following tasks:

1. Insert Fixing Block

(1) Put the Fixing Block to fix the Magnetic Pillar frame.

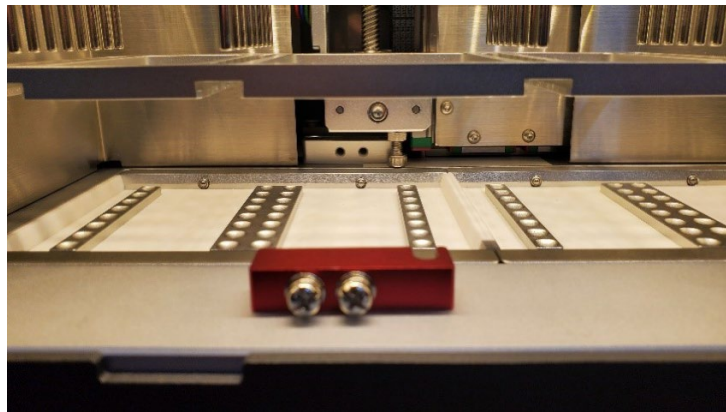

(2) Install the Fixing Block

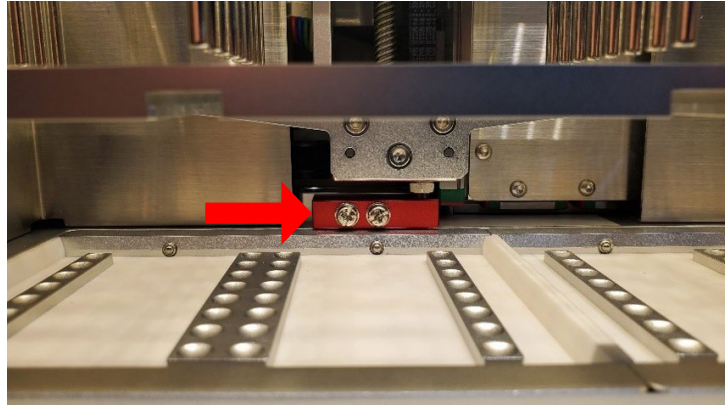

(3) Use Phillips head screwdriver for the red screw

(4) Close the door

2. Disconnect the plug from the outlet and remove all attached parts (Power Cord) from the instrument.

Warning:

If the power cable is damaged, this may cause a device failure, fire, injury, or electric shock.



3. Pack the **ZiXpress 64 Dx system** instrument, including accessories in its original shipping box or some other equivalent parcel.

Functional Descriptions

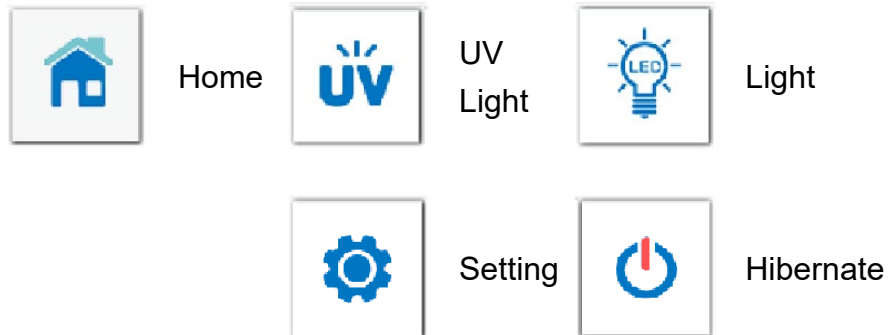
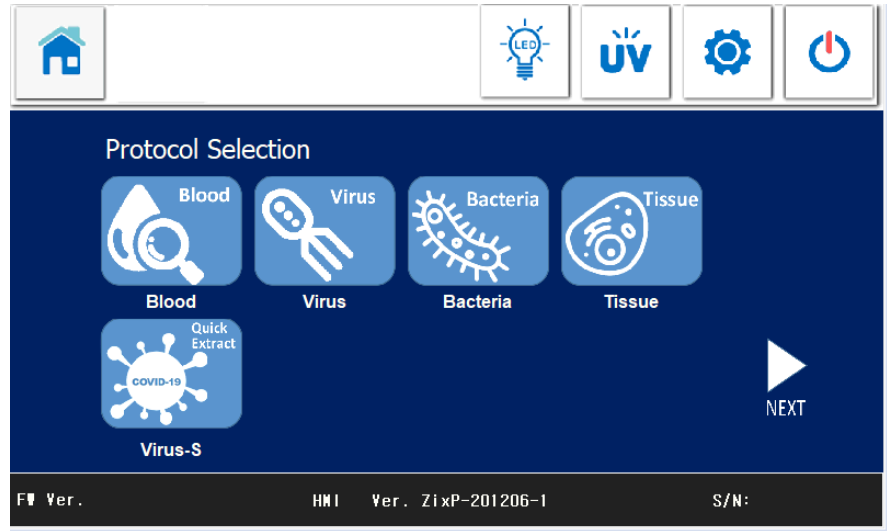
Main Menu



LED Light

After pressing  button, the icon will change into  , the instrument's light will turn off.

UV Light

After pressing  button, Press <30 minutes> to start a default 30 minutes decontamination process or press <User setting> to set a desired time.

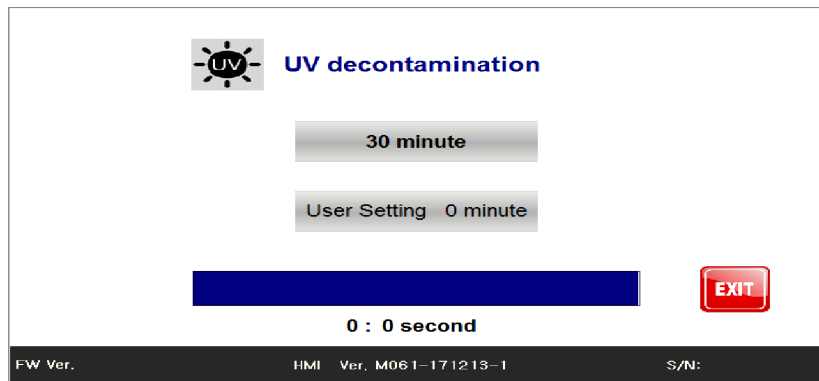
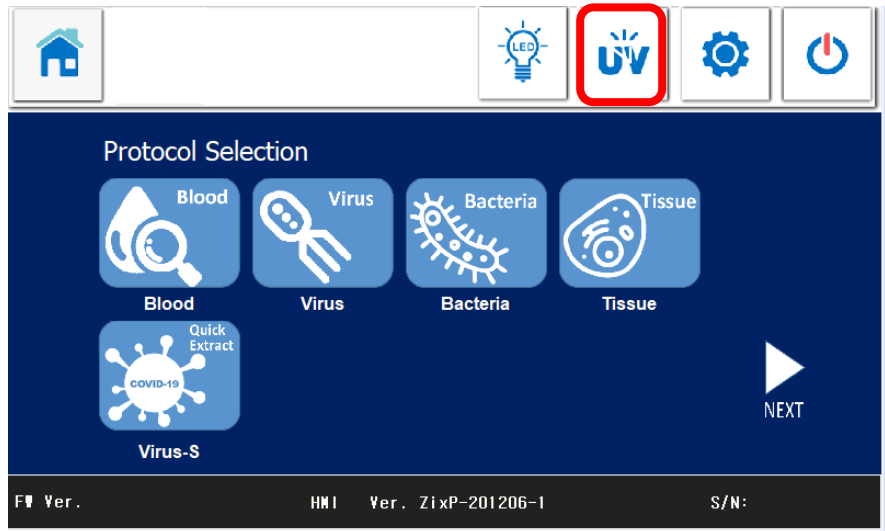

Settings

After pressing  button, you can do the instrument adjustment / check / test.

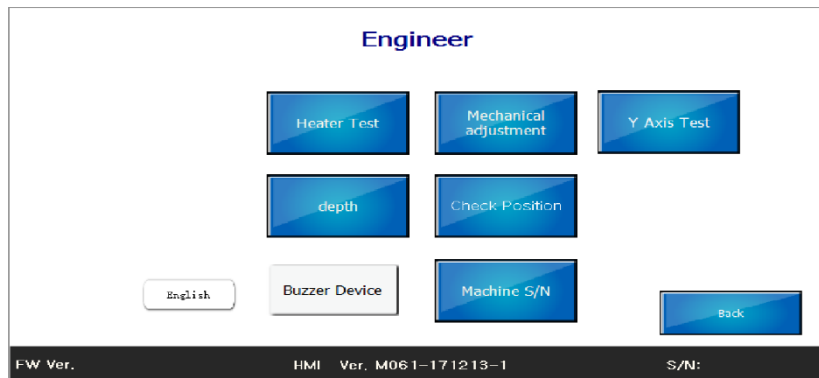

Sleeping mode

After pressing  button, the instrument will get into the “sleeping mode”. If you want to wake up the instrument, touch the screen again.

Note:

Before getting into the sleeping mode, please press  button first to turn off the LED light.

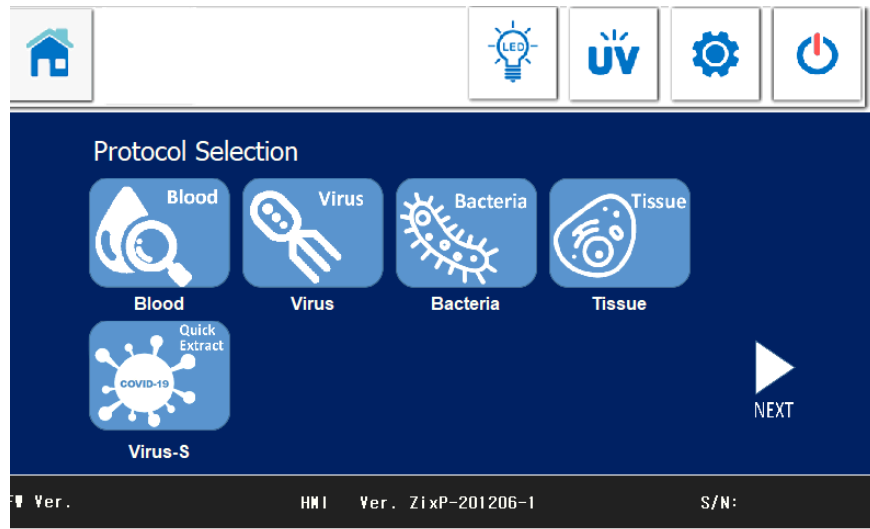

GETTING STARTED

Preparation



Biohazard:

Always wear appropriate gloves, a mask, and safety goggles during any biohazardous operations in extraction process. Even when touching the device after any operation with a biohazard risk, wear appropriate gloves and a mask since the device may be contaminated.

Important:

Before starting the extraction, put on appropriate gloves, a mask, and safety goggles if required by the operation. Be careful not to contaminate the sample material with sweat, saliva, etc., within the sample preparation steps.

The following items are required for extraction operation:

- Gloves
- Mask
- Safety Goggles
- Extraction Kit Handbook
+ Reagent Plates and Mixing Sleeves
(Provided in Reagent Kits)

Operation

Operation Procedure

- (1) Make sure that the power cable is securely connected to the **ZiXpress 64 Dx system**.
- (2) Connect the plug of the power cable to the outlet.

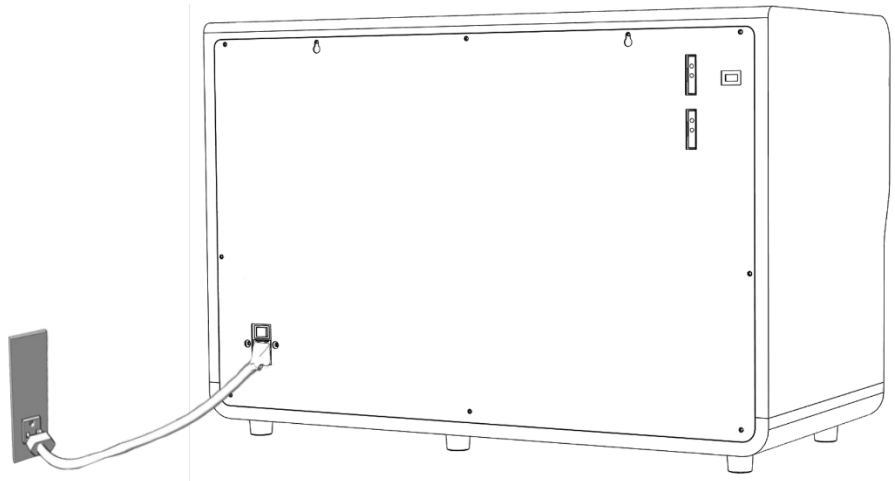

- (3) Turn the power switch on and wait for the Touch Panel to turn on and displaying “**ZiXpress 64 Dx system** initializing”. The system will process self-testing, and then go to steady mode.

Note:

The system will block main functions before the completion of self-testing process.

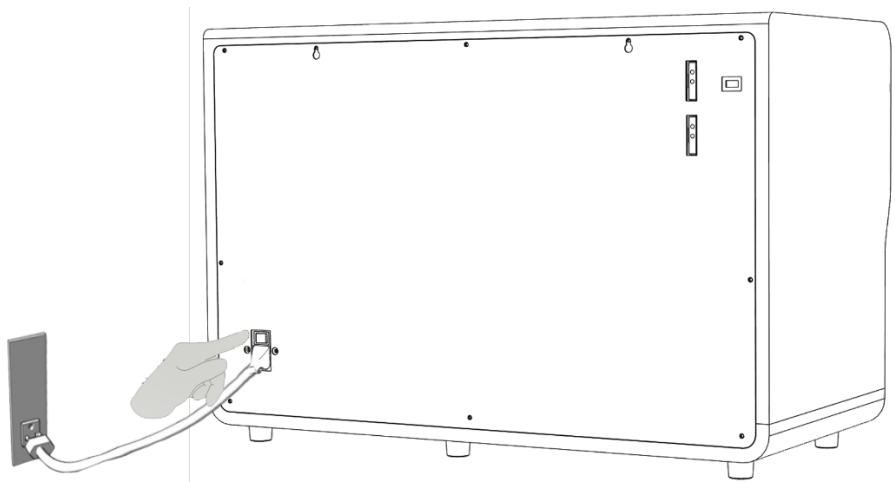

(4) Open the door.

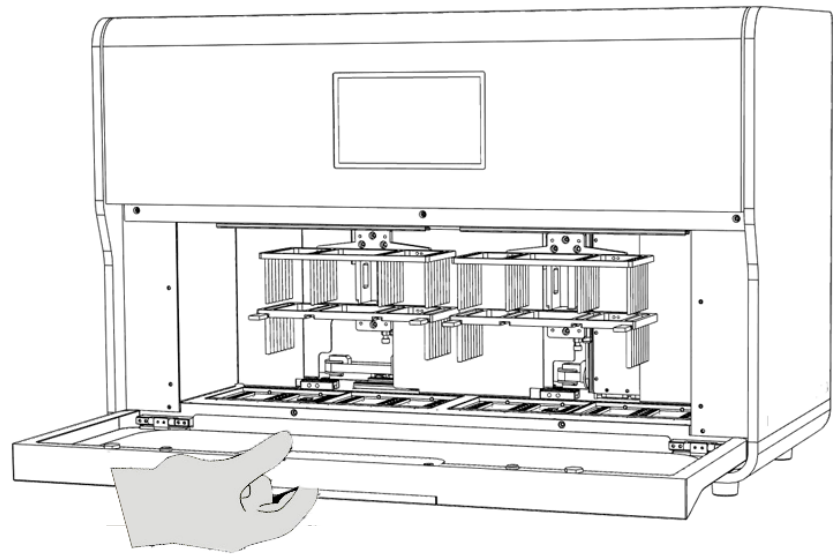

(5) Set up the mixing sleeves on the mixing sleeve track.

 **Caution:**

Make sure the sleeves have entered completely!

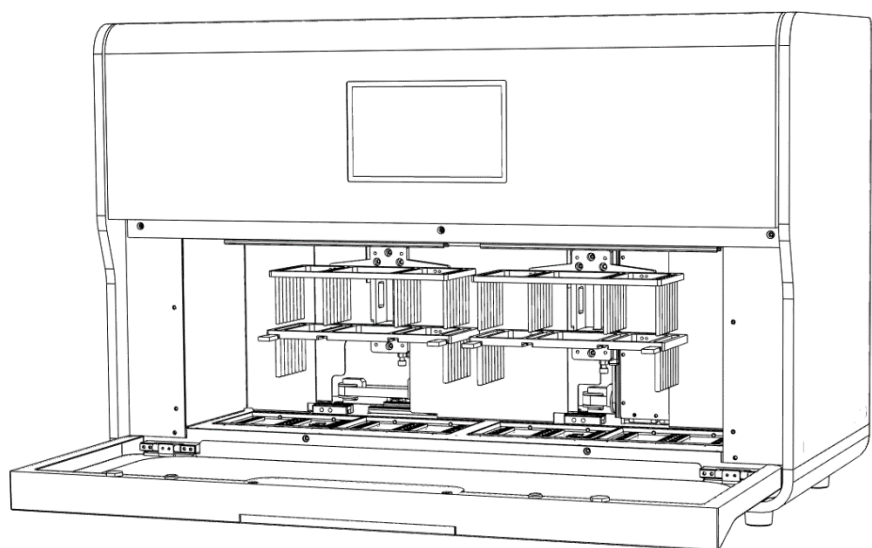

- (6)** Remove carefully the aluminum foil sealing membrane on the reagent plate. Add samples to Well 1 and Well 7.

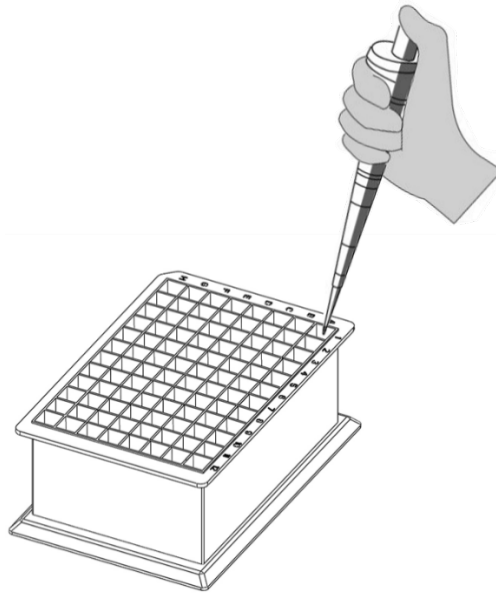

- (7)** Place the reagent plate(s) into the instrument.

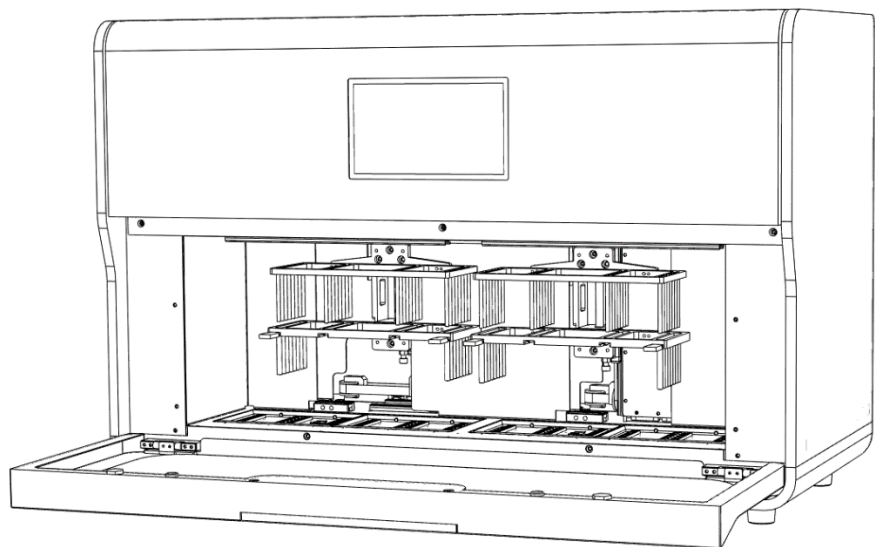

- (8)** Close the door before starting the instrument!

(9) Select protocol

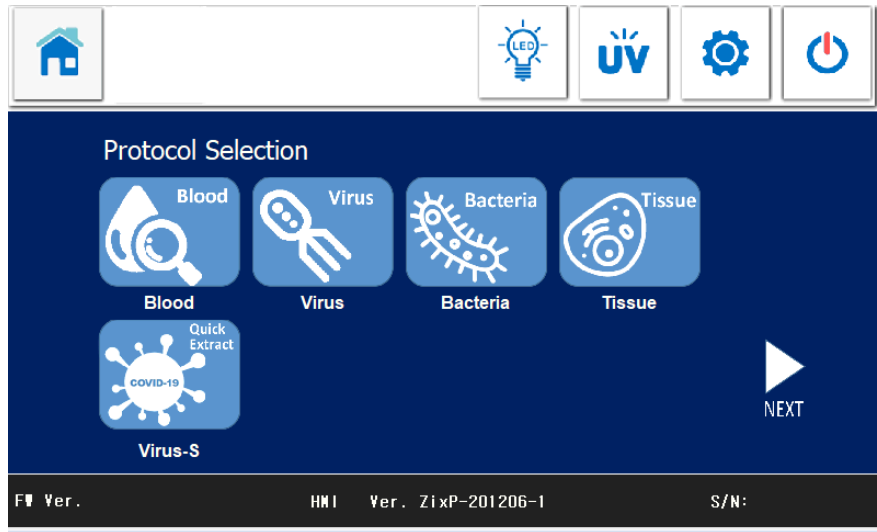

Select the pre-installed protocols.

This figure is the standard protocol in **ZiXpress 64 Dx system**:

Now :

Time: 0 hr 0 min 0 sec Remain Time: 0 hr 40 min 40 sec

No: 17-1 Protocol Name: **Blood** 0°C | 0°C

RUN	Well No. (0-6)	Name	Standby (0-30Min)	Mix (1-30Min)	Volume (100-1000ul)	Mix Speed (1-3)	Mag (0-120Sec)	Temp. (40-80°C)	Pause
<input checked="" type="checkbox"/>	3	Transfer	0	1	900	3	60	0	<input type="checkbox"/>
<input checked="" type="checkbox"/>	1	Lysis	0	12	940	2	40	75	<input type="checkbox"/>
<input checked="" type="checkbox"/>	2	WASH 1	0	2	100	3	0	0	<input type="checkbox"/>
<input checked="" type="checkbox"/>	2	WASH 1	0	3	900	3	40	0	<input type="checkbox"/>
<input checked="" type="checkbox"/>	3	WASH 2	0	1	100	3	0	0	<input type="checkbox"/>
<input checked="" type="checkbox"/>	3	WASH 2	0	2	900	3	40	0	<input type="checkbox"/>
<input checked="" type="checkbox"/>	4	WASH 3	0	2	100	3	0	0	<input type="checkbox"/>
<input checked="" type="checkbox"/>	4	WASH 3	0	2	900	2	40	0	<input type="checkbox"/>

 Please ensure all the parameters are correct before click on the next button

Now :

Time: 0 hr 0 min 0 sec Remain Time: 0 hr 40 min 40 sec

No: 17-2 Protocol Name: **Blood** 0°C | 0°C

RUN	Well No. (0-6)	Name	Standby (0-30Min)	Mix (1-30Min)	Volume (100-1000ul)	Mix Speed (1-3)	Mag (0-120Sec)	Temp. (40-80°C)	Pause
<input checked="" type="checkbox"/>	6	ELUTE	5	5	100	3	60	80	<input type="checkbox"/>
<input checked="" type="checkbox"/>	4	WASTE	0	1	900	3	0	0	<input type="checkbox"/>

Cancel Please ensure all the paramters are correct before click on the next button Previous

(10) Press to start the extraction process.

Note:

The process time and remaining process time will be displayed on the screen.

(11) While the extraction procedure is finished, transfer the extracted products located at Well 6 and Well 12 into nuclease-free tubes.

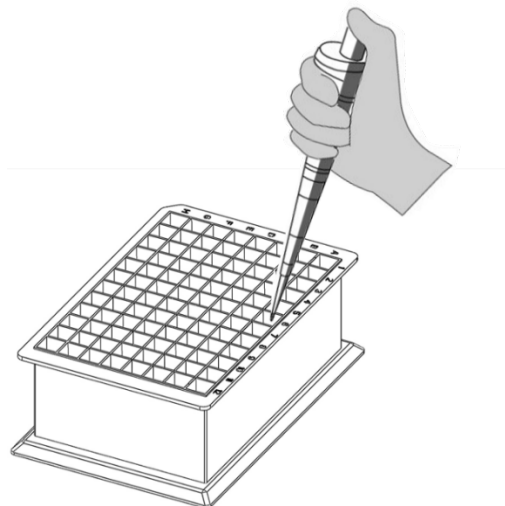

Note:

Store the purified nucleic acid at 4°C (short-term, less than 10 days) or aliquot and store at -70°C (long-term) before performing any downstream analysis.

(12) Discard the used consumables into biohazard waste.

(13) If you are not using the instrument in short-term, press



button to get into “sleeping mode”.

Pause & Restart Procedures

(1) If you want to stop / pause the procedure during the

operation, please press button.

Now :

Time: 0 hr 0 min 0 sec Remain Time: 0 hr 40 min 40 sec

No: 17-1 Protocol Name: Blood 0°C | 0°C

RUN	Well No. (0-6)	Name	Standby (0-30Min)	Mix (1-30Min)	Volume (100-1000ul)	Mix Speed (1-3)	Mag (0-120Sec)	Temp. (40-80°C)	Pause
✓	3	Transfer	0	1	900	3	60	0	<input type="checkbox"/>
✓	1	Lysis	0	12	940	2	40	75	<input type="checkbox"/>
✓	2	WASH 1	0	2	100	3	0	0	<input type="checkbox"/>
✓	2	WASH 1	0	3	900	3	40	0	<input type="checkbox"/>
✓	3	WASH 2	0	1	100	3	0	0	<input type="checkbox"/>
✓	3	WASH 2	0	2	900	3	40	0	<input type="checkbox"/>
✓	4	WASH 3	0	2	100	3	0	0	<input type="checkbox"/>
✓	4	WASH 3	0	2	900	2	40	0	<input type="checkbox"/>

Please ensure all the paramters are correct before click on the next button Next

(2) To restart the procedure, press button

Now :

Time: 0 hr 0 min 0 sec Remain Time: 0 hr 40 min 40 sec

No: 17-1 Protocol Name: Blood 0°C | 0°C

RUN	Well No. (0-6)	Name	Standby (0-30Min)	Mix (1-30Min)	Volume (100-1000ul)	Mix Speed (1-3)	Mag (0-120Sec)	Temp. (40-80°C)	Pause
✓	3	Transfer	0	1	900	3	60	0	<input type="checkbox"/>
✓	1	Lysis	0	12	940	2	40	75	<input type="checkbox"/>
✓	2	WASH 1	Suspended...		0	3	0	0	<input type="checkbox"/>
✓	2	WASH 1	0	3	900	3	40	0	<input type="checkbox"/>
✓	3	WASH 2	0	1	100	3	0	0	<input type="checkbox"/>
✓	3	WASH 2	0	2	900	3	40	0	<input type="checkbox"/>
✓	4	WASH 3	0	2	100	3	0	0	<input type="checkbox"/>
✓	4	WASH 3	0	2	900	2	40	0	<input type="checkbox"/>

Please ensure all the paramters are correct before click on the next button Next

Stop the Process

(1) During the process, if you want to stop/pause the

procedure, please press button.

Now :
 Time: 0 hr 0 min 0 sec **Remain Time: 0 hr 40 min 40 sec**

No: 17-1 Protocol Name: **Blood** 0°C | 0°C

RUN	Well No. (0-6)	Name	Standby (0-30Min)	Mix (1-30Min)	Volume (100-1000ul)	Mix Speed (1-3)	Mag (0-120Sec)	Temp. (40-80°C)	Pause
<input checked="" type="checkbox"/>	3	Transfer	0	1	900	3	60	0	<input type="checkbox"/>
<input checked="" type="checkbox"/>	1	Lysis	0	12	940	2	40	75	<input type="checkbox"/>
<input checked="" type="checkbox"/>	2	WASH 1	0	2	100	3	0	0	<input type="checkbox"/>
<input checked="" type="checkbox"/>	2	WASH 1	0	3	900	3	40	0	<input type="checkbox"/>
<input checked="" type="checkbox"/>	3	WASH 2	0	1	100	3	0	0	<input type="checkbox"/>
<input checked="" type="checkbox"/>	3	WASH 2	0	2	900	3	40	0	<input type="checkbox"/>
<input checked="" type="checkbox"/>	4	WASH 3	0	2	100	3	0	0	<input type="checkbox"/>
<input checked="" type="checkbox"/>	4	WASH 3	0	2	900	2	40	0	<input type="checkbox"/>

Please ensure all the paramters are correct before click on the next button **Next**

(2) To stop the process, press button,

Now :
 Time: 0 hr 0 min 0 sec **Remain Time: 0 hr 40 min 40 sec**

No: 17-1 Protocol Name: **Blood** 0°C | 0°C

RUN	Well No. (0-6)	Name	Standby (0-30Min)	Mix (1-30Min)	Volume (100-1000ul)	Mix Speed (1-3)	Mag (0-120Sec)	Temp. (40-80°C)	Pause
<input checked="" type="checkbox"/>	3	Transfer	0	1	900	3	60	0	<input type="checkbox"/>
<input checked="" type="checkbox"/>	1	Lysis	0	12	940	2	40	75	<input type="checkbox"/>
<input checked="" type="checkbox"/>	2	WASH 1	0	2	100	3	0	0	<input type="checkbox"/>
<input checked="" type="checkbox"/>	2	WASH 1	0	3	900	3	40	0	<input type="checkbox"/>
<input checked="" type="checkbox"/>	3	WASH 2	0	1	100	3	0	0	<input type="checkbox"/>
<input checked="" type="checkbox"/>	3	WASH 2	0	2	900	3	40	0	<input type="checkbox"/>
<input checked="" type="checkbox"/>	4	WASH 3	0	2	100	3	0	0	<input type="checkbox"/>
<input checked="" type="checkbox"/>	4	WASH 3	0	2	900	2	40	0	<input type="checkbox"/>

Please ensure all the paramters are correct before click on the next button **Next**

(3) Press <Yes>, then the instrument will do the initializing.

Interrupt

No

Yes

FW Ver.
HMI Ver. M061-171213-1
S/N:

After Extraction Process

- (1) Transfer the extracted products located at Well 6 and Well 12 into nuclease-free tubes.

Note:

You can apply quality checking, do downstream study or storage them as what you expect.

- (2) Remove the used plastic disposables from the instrument and dispose them.
- (3) Follow the suggested Maintenance Routines.

CLEANING & MAINTENANCE

ZiXpress 64 Dx system Cleaning

- After every operation of purification, please properly remove used plastic consumables.
- At the end of every working day, please wipe clean any fluid that remains on the inside and outside of the instrument with damp cloth, use 75% ethanol and UV light to disinfect the surface.

Note:

Press  button to get into the UV light mode, and select the disinfecting time.

- Clean the instrument body by removing dust gently with a dry, soft cloth. If the outside of the **ZiXpress 64 Dx system** is heavily soiled, or if any samples that may cause infection are adhered to the outside of the **ZiXpress 64 Dx system**, wipe with a soft paper tissue, soaked with 75% ethanol.

ZiXpress 64 Dx system Maintenance

Two types of maintenance have to be performed on the **ZiXpress64 Dx system** instrument, for details on each type of maintenance, see the list below:

Maintenance Type	Performed by	Schedule
<i>Routine</i> Cleaning instrument body (outside)	User	Bi-weekly
Cleaning instrument body (inside)	User	Daily
<i>Preventive</i>	Service Engineer	Annually

TROUBLESHOOTING

Problem	Cause	Solution
No display after turned on the power switch.	Power disconnected	Check AC power cord connections at both ends. Or use the correct cords.
	Blown fuse	Replace the fuse
	Malfunction power switch	Replace the switch
	Others	Contact your local representative / agent
Touch Panel turns on when the power is on but the self-testing program does not run	Forget to remove the fixing block from instrument	Turn off the instrument and remove the fixing block.
	Technical problem	Contact your local representative / agent
The beeping alarm sound or “System error” message on the display	Self-check error	Contact your local representative / agent
Display error	Firmware installing failed	Contact your local representative / agent
	Display connection failed	Contact your local representative / agent
Cannot enter on the Touch Panel	Touch Panel malfunction	Contact your local representative / agent

CONTACT ZINEXTS LIFE SCIENCE

Company Information

Legal Name: **Zinexts Life Science Corp.**
Web: www.zinexts.com
Address: 16F., No. 93, Sec. 1, Xintai 5th Rd.,
Xizhi Dist., New Taipei City 221416 ,
Taiwan (R.O.C)
Tel: +886 2 2246 3579
Fax: +886 2 2243 8570
Mail: info@zinexts.com

Manufacturer Information

Manufacturing facility: **Zinexts Life Science Corp.**
Address: 16F., No. 93, Sec. 1, Xintai 5th Rd.,
Xizhi Dist., New Taipei City 221416 ,
Taiwan (R.O.C)
Tel: +886 2 2246 3579
Fax: +886 2 2243 8750
Mail: info@zinexts.com
Product of Origin: Taiwan (R.O.C.)

Technical Support

Zinexts Life Science - Service Center

For technical problem and instrument maintenance please contact our service center: support@zinexts.com

Before contacting the Technical Support, refer to “Troubleshooting” to check the problems. If the issue cannot be solved, contact your local representative / agent, or the Zinexts Life Science - Service Center.

WARRANTY INFORMATION

Product
Warranty

1. The general warranty period for the instrument is 12 months from the delivery day of the product.
2. The warranty does not cover any problem that is caused by
 - (i) Conditions, malfunctions or damage not resulting from defects in material or workmanship.
 - (ii) Any consumption spare parts including fuses, light bulbs, UV lights, LED lighting sets.
3. For further information about the Warranty Policy and Extended Warranty offers, please contact your local representative / agent, or visit our website www.zinexts.com.

Zinexts Life Science Corp.

www.zinexts.com

16F., No. 93, Sec. 1, Xintai 5th Rd., Xizhi Dist.,

New Taipei City 221416 , Taiwan (R.O.C)

Tel: +886 2 2246 3579

Fax: +886 2 2243 8570

Mail: info@zinexts.com

Revision History

VER	Location of changes	Essence of changes
1.6	Upper right of the page	2024.10.01 Change company logo